

INDUSTRIAL SECTION

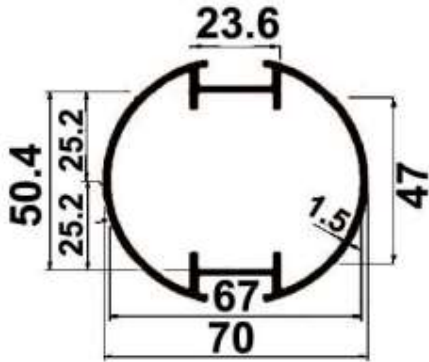

SI NO	SECTION NO.	WEIGHT(KG/M)
1	2520	1.130

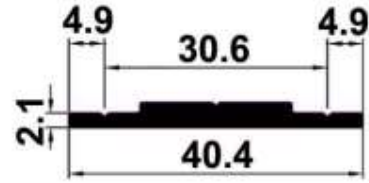

SI NO	SECTION NO.	WEIGHT(KG/M)
1	5520	0.313

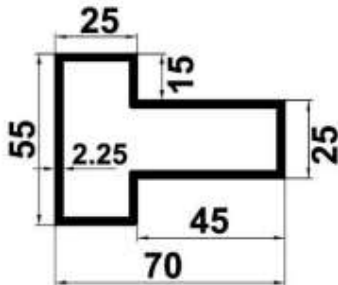

SI NO	SECTION NO.	WEIGHT(KG/M)
1	5521	1.464

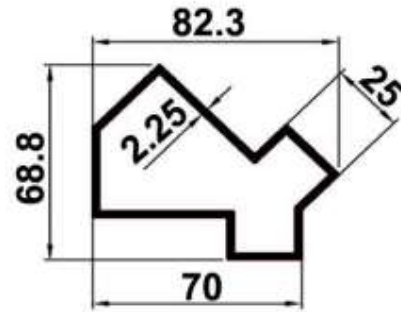

SI NO	SECTION NO.	WEIGHT(KG/M)
1	5522	1.577

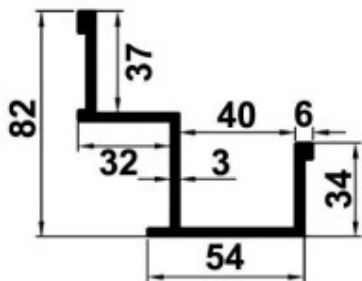

SI NO	SECTION NO.	WEIGHT(KG/M)
1	5524	1.078

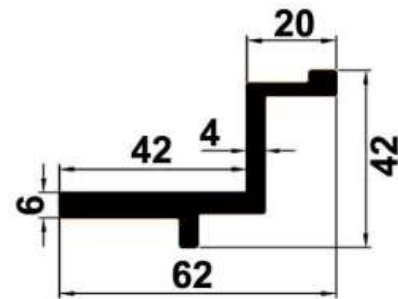

SI NO	SECTION NO.	WEIGHT(KG/M)
1	5525	1.234

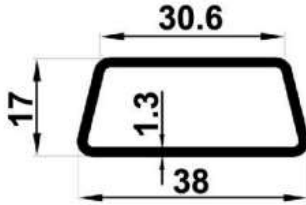

SI NO	SECTION NO.	WEIGHT(KG/M)
1	5528	0.339

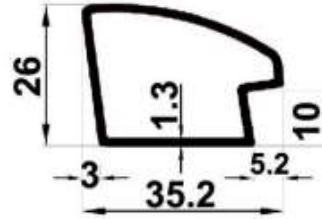

SI NO	SECTION NO.	WEIGHT(KG/M)
1	5529	0.374

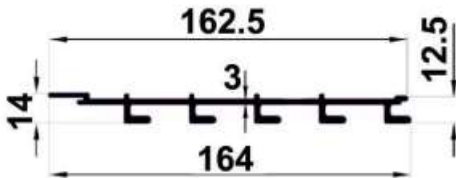

SI NO	SECTION NO.	WEIGHT(KG/M)
1	5536	1.563

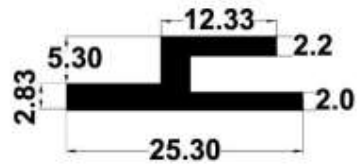

SI NO	SECTION NO.	WEIGHT(KG/M)
1	5101	0.257

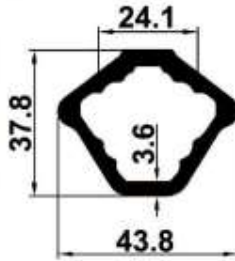

SI NO	SECTION NO.	WEIGHT(KG/M)
1	6004	1.109

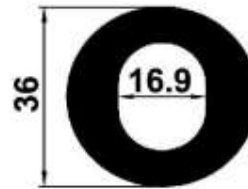

SI NO	SECTION NO.	WEIGHT(KG/M)
1	6006	1.190

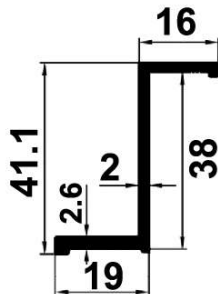

SI NO	SECTION NO.	WEIGHT(KG/M)
1	6406	0.427

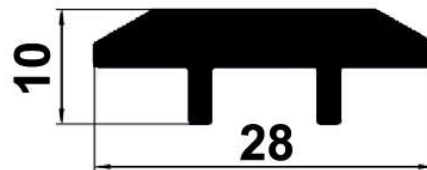

SI NO	SECTION NO.	WEIGHT(KG/M)
1	6407	0.385

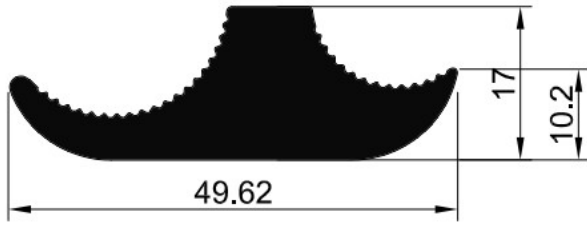

SI NO	SECTION NO.	WEIGHT(KG/M)
1	9130	1.169

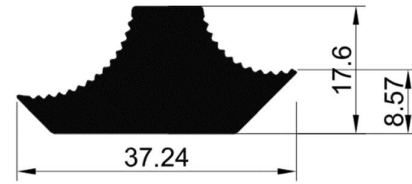

SI NO	SECTION NO.	WEIGHT(KG/M)
1	9132	0.928

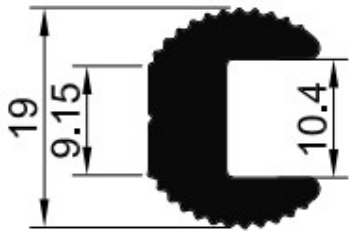

SI NO	SECTION NO.	WEIGHT(KG/M)
1	9134	0.438

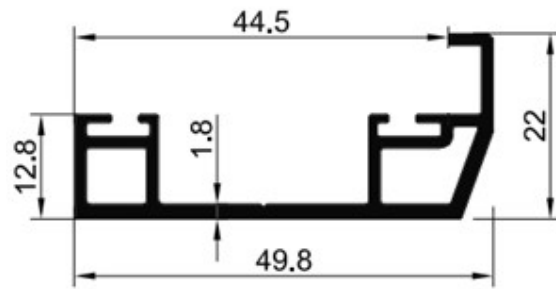

SI NO	SECTION NO.	WEIGHT(KG/M)
1	9136	0.548

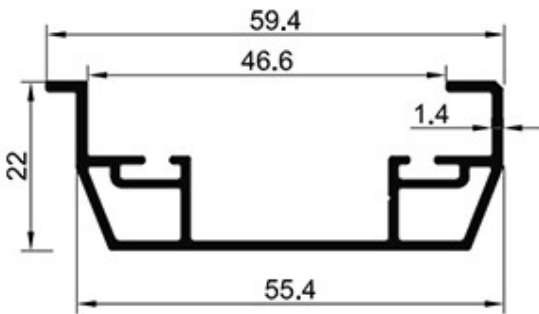

SI NO	SECTION NO.	WEIGHT(KG/M)
1	9138	0.532

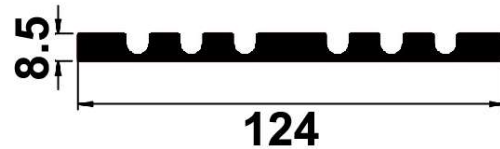

SI NO	SECTION NO.	WEIGHT(KG/M)
1	9315	2.158

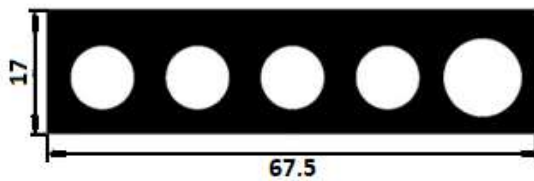

SI NO	SECTION NO.	WEIGHT(KG/M)
1	9316	2.153

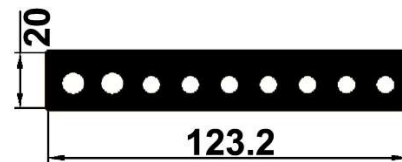

SI NO	SECTION NO.	WEIGHT(KG/M)
1	9318	5.087

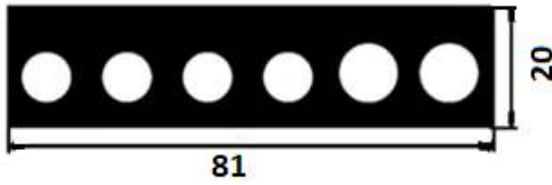

SI NO	SECTION NO.	WEIGHT(KG/M)
1	9319	3.333

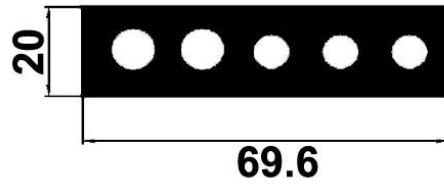

SI NO	SECTION NO.	WEIGHT(KG/M)
1	9320	2.874

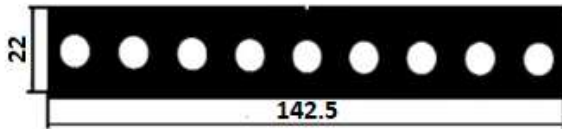

SI NO	SECTION NO.	WEIGHT(KG/M)
1	9323	7.082

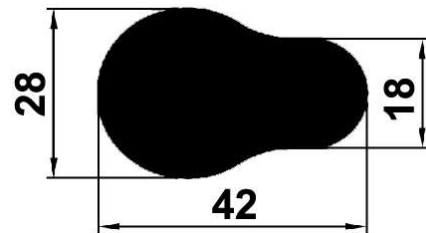

SI NO	SECTION NO.	WEIGHT(KG/M)
1	9330	2.314

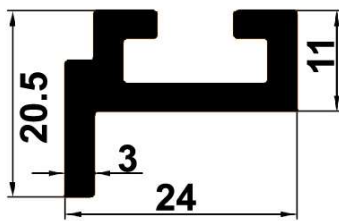

SI NO	SECTION NO.	WEIGHT(KG/M)
1	9705	0.303

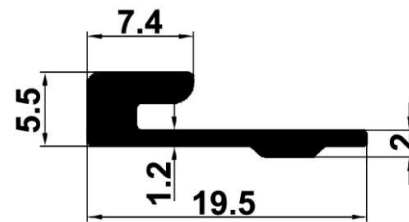

SI NO	SECTION NO.	WEIGHT(KG/M)
1	9706	0.135

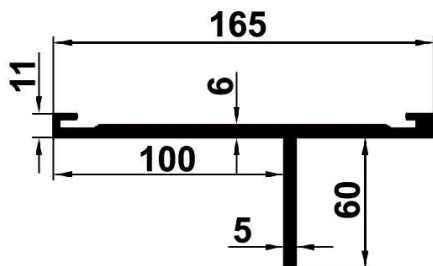

SI NO	SECTION NO.	WEIGHT(KG/M)
1	9708	3.542

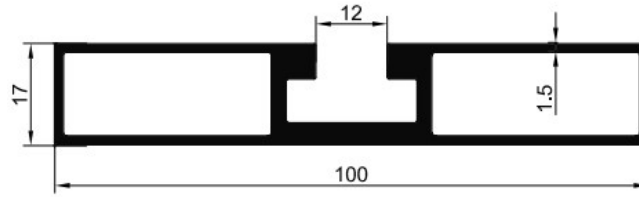

SI NO	SECTION NO.	WEIGHT(KG/M)
1	9150	1.316

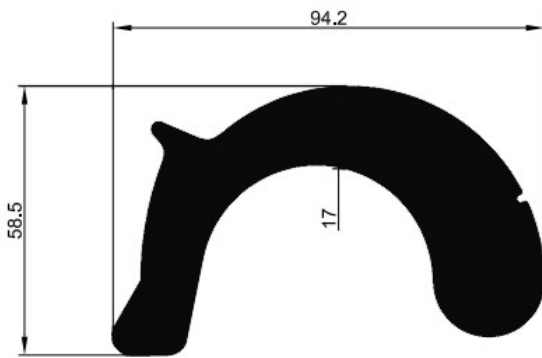

SI NO	SECTION NO.	WEIGHT(KG/M)
1	5476	6.603

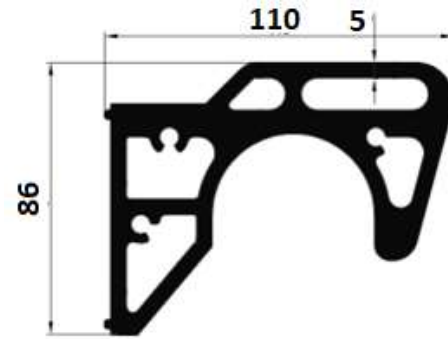

SI NO	SECTION NO.	WEIGHT(KG/M)
1	5474	7.842

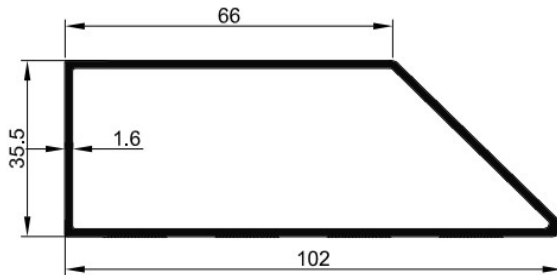

SI NO	SECTION NO.	WEIGHT(KG/M)
1	5480	1.092